

Dealer's Manual

Cassette Sprocket

CS-M9000
CS-HG400-9
CS-HG300-9
CS-HG200-9
CS-HG200-8
CS-HG50-9
CS-HG50-8

IMPORTANT NOTICE

- **This dealer's manual is intended primarily for use by professional bicycle mechanics.**

Users who are not professionally trained for bicycle assembly should not attempt to install the components themselves using the dealer's manuals.

If any part of the information on the manual is unclear to you, do not proceed with the installation. Instead, contact your place of purchase or a local bicycle dealer for their assistance.

- Make sure to read all instruction manuals included with the product.
- Do not disassemble or modify the product other than as stated in the information contained in this dealer's manual.
- All dealer's manuals and instruction manuals can be viewed on-line on our website (<http://si.shimano.com>).
- Please observe the appropriate rules and regulations of the country, state or region in which you conduct your business as a dealer.

For safety, be sure to read this dealer's manual thoroughly before use, and follow it for correct use.

The following instructions must be observed at all times in order to prevent personal injury and physical damage to equipment and surroundings.

The instructions are classified according to the degree of danger or damage which may occur if the product is used incorrectly.

 **DANGER**

Failure to follow the instructions will result in death or serious injury.

 **WARNING**

Failure to follow the instructions could result in death or serious injury.

 **CAUTION**

Failure to follow the instructions could cause personal injury or physical damage to equipment and surroundings.

TO ENSURE SAFETY

WARNING

- When installing components, be sure to follow the instructions that are given in the instruction manuals.

It is recommended that you use only genuine Shimano parts. If parts such as bolts and nuts become loose or damaged, the bicycle may suddenly fall over, which may cause serious injury.

In addition, if adjustments are not carried out correctly, problems may occur, and the bicycle may suddenly fall over, which may cause serious injury.

-  Be sure to wear safety glasses or goggles to protect your eyes while performing maintenance tasks such as replacing parts.
- After reading the dealer's manual thoroughly, keep it in a safe place for later reference.

NOTE

Be sure to also inform users of the following:

- Products are not guaranteed against natural wear and deterioration from normal use and aging.
- If the chain keeps coming off the chainrings during use, replace the chainrings and the chain.
- For maximum performance we highly recommend Shimano lubricants and maintenance products.

For Installation to the Bicycle, and Maintenance:

- You should periodically wash the chainrings in a neutral detergent. In addition, cleaning the chain with neutral detergent and lubricating it can be an effective way of extending the useful life of the chainrings and the chain.
- Always use the recommended combination of gears.
- Always be sure to use the sprocket set bearing the same group marks. Never use in combination with a sprocket bearing a different group mark.

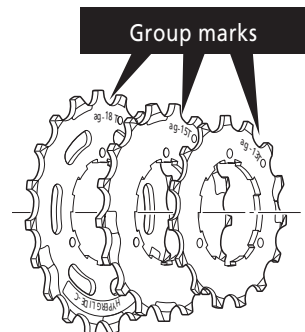

- Do not use the CS-HG400-9, CS-HG300-9, CS-HG200-9, CS-HG50-9 in any combination other than with the CN-7701, CN-HG53, CN-HG73, CN-HG93. Other chains cannot be used as the sizes do not match.
- Do not use the CS-M9000 in any combination other than with the CN-HG900-11. Other chains cannot be used as the sizes do not match.
- Do not use the CS-HG200-8, CS-HG50-8 in any combination other than with the CN-UG51, CN-HG40, CN-HG50, CN-HG70, CN-HG91. Other chains cannot be used as the sizes do not match.

The actual product may differ from the illustration because this manual is intended chiefly to explain the procedures for using the product.

INSTALLATION

■ List of tools to be used

Usage location	Tool	Note
Lock ring	TL-LR15 / 10	Installation tool
	TL-LR15 / 10 & TL-SR21 / 23	Removal tool

■ Installation of cassette sprocket

For each sprocket, the surface that has the group mark should face outward and be positioned so that the wide parts of the gear projections on each sprocket and the A part (where the groove width is wide) of the freewheel body are aligned.

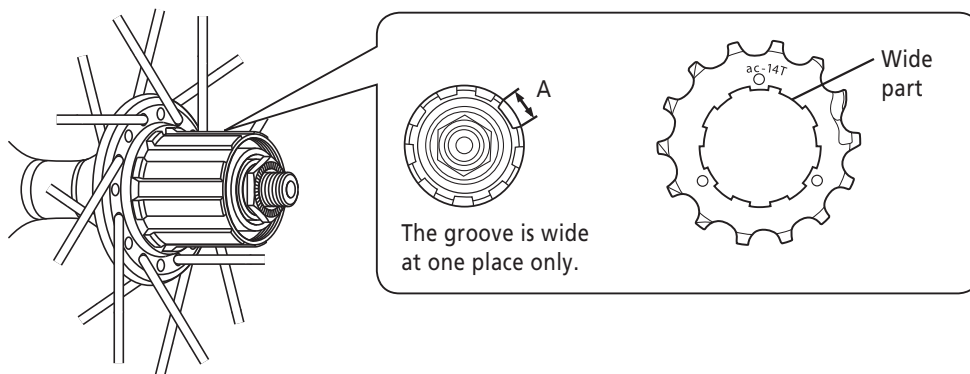

- For installation of the HG sprockets, use the special tool TL-LR15 / LR10 to tighten the lock ring.

Tightening torque:
30.0 - 50.0 N·m {262 - 437 in. lbs.}

- To replace the HG sprockets, use the special tool TL-LR15 / LR10 and TL-SR21 / 23 to remove the lock ring.

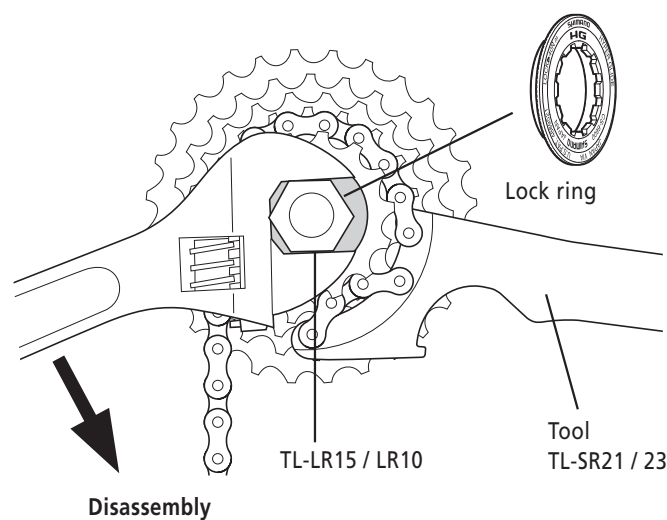

■ Sprocket pattern

CS-M9000

< 11T - 40T (bs) >

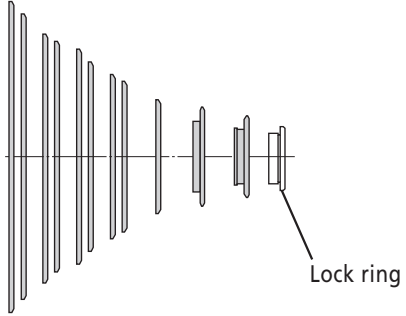

CS-HG400-9 / CS-HG300-9

< 11T - 32T (ar), 11T - 34T (au) >

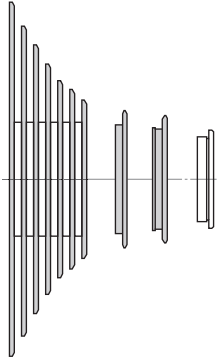

< 12T - 36T (bh) >

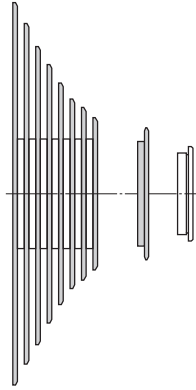

< 11T - 28T (bg) >

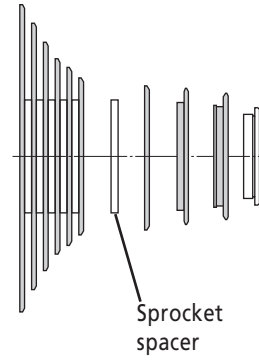

CS-HG50-9 / CS-HG200-9

< 11T - 25T >

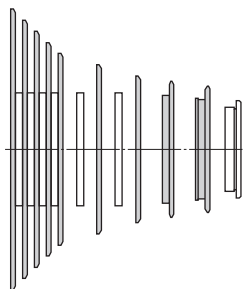

< 12T - 23T, 12T - 25T, 12T - 27T >

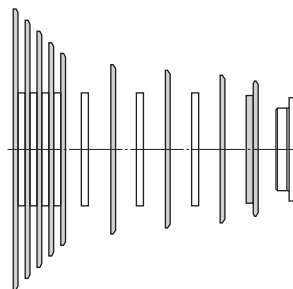

< 11T - 30T, 11T - 32T, 11T - 34T >

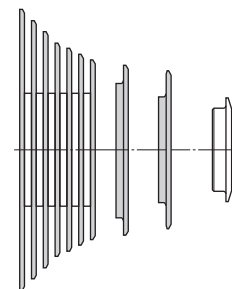

< 13T - 25T >

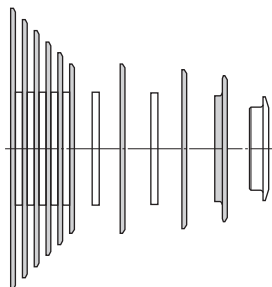

< 14T - 25T >

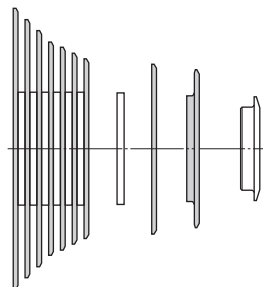

CS-HG50-8

< 11-28T (bf), 11-30T (an), 11-32T (aw) >

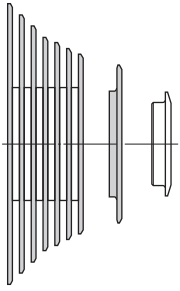

CS-HG200-8

< 14-32T (br) >

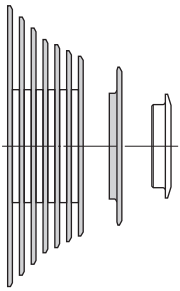

SHIMANO

SHIMANO AMERICAN CORPORATION

One Holland, Irvine, California 92618, U.S.A. Phone: +1-949-951-5003

SHIMANO EUROPE B.V.

Industrieweg 24, 8071 CT Nunspeet, The Netherlands Phone: +31-341-272222

SHIMANO INC.

3-77 Oimatsu-cho, Sakai-ku, Sakai-shi, Osaka 590-8577, Japan

Please note: specifications are subject to change for improvement without notice. (English)

© Feb. 2014 by Shimano Inc. HTR